

SGM[®] X-5 / XC-5
LED STROBE

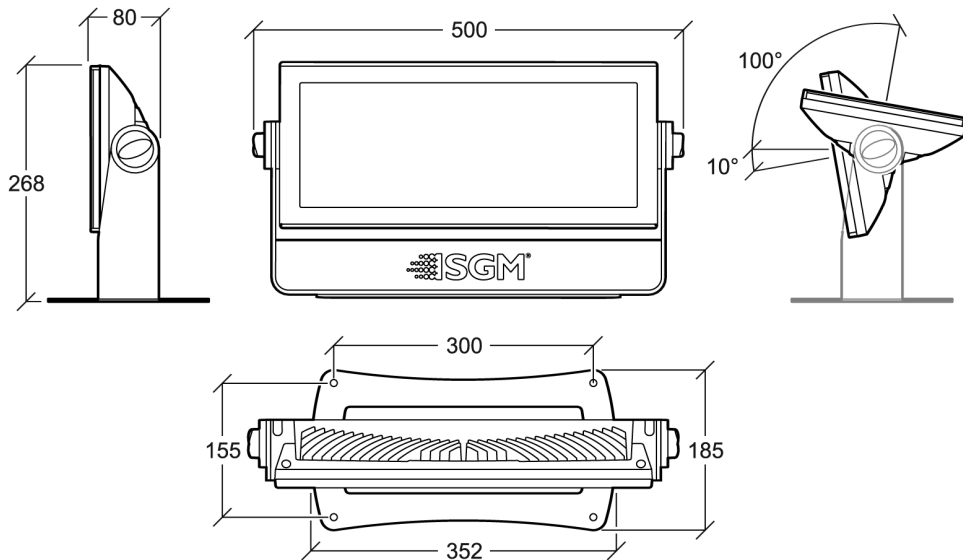

X-5 / XC-5 LED Strobe dimensions



X-5 / XC-5 LED STROBE USER MANUAL REV. 3d ETL

© 2014 SGM™. Information subject to change without notice. SGM and all affiliated companies disclaim liability for any injury, damage, direct or indirect loss, consequential or economic loss or any other loss occasioned by the use of, inability to use or reliance on the information contained in this manual. The SGM logo, the SGM name and all other trademarks in this document pertaining to services or products by SGM or its affiliates and subsidiaries are trademarks owned or licensed by SGM or its affiliates or subsidiaries.

X-5 / XC-5 LED Strobe

Contents

Safety Information.....	5
Preparation for Use.....	7
Controller Operation.....	9
Setup.....	10
DMX Control Summary.....	12
Service.....	14
DMX Protocols.....	15
Specifications.....	20
Users notes.....	22

Safety Information



WARNING!

This product is for professional use only! It is not for household use.

Strobe lights are known to trigger epileptic seizures in persons who are photosensitive.

This product must be installed in accordance with the applicable installation code by a person familiar with the construction and operation of the product and the hazards involved.

Ce produit doit être installé selon le code d'installation pertinent, par une personne qui connaît bien le produit et son fonctionnement ainsi que les risques inhérents.



To guard against electric shock.

- Do not open: there are no user-serviceable parts inside.
- Always ground (earth) the fixture electrically.
- Use only a source of AC power that complies with local building and electrical codes and has both overload and earth leakage protection.
- Do not expose the fixture to rain or moisture.



To guard against UV radiation, burn, and fire.

- Do not stare directly into the light.
- Never attempt to bypass the fuse. Always replace defective fuses with ones of the specified type and rating.
- Verify that the power feed cable is rated for the current draw of all connected fixtures.
- Keep all combustible materials (for example fabric, wood, paper) at least 0.5 meters (20 inches) away from the fixture. Keep flammable materials well away from the fixture.
- Provide a minimum clearance of 0.1 meters (4 inches) around air vents.
- Do not modify the fixture or install other than genuine SGM parts.
- Do not operate the fixture if the ambient air temperature (Ta) exceeds 40° C (104°F).
- Caution: Exterior surface temperature after 5 min. operation = 40°C (104°F) Steady state = 75°C (195° F).



To guard against epileptic seizure..

- Do not operate the fixture near stairways.
- Provide advance notice that strobe lighting is in use.
- Avoid extended periods of continuous flashing, particularly at frequencies of 10 to 20 flashes per second.

Preparation for Use

Unpacking

- Strobe Light Fixture
- User manual
- Mains power cable
- Foot – black aluminium plate

The packing material protects the fixture during shipment, please retain for future transportation of the fixture.

AC Power Connection





The auto-ranging power supply automatically adjusts to AC power from 208-240 volts nominal at 50/60 Hz. The current required by the X-5/XC-5 is 4 amps. To avoid overload, allow one 4 amp branch circuit per fixture to operate the X-5/XC-5 model at full power.

Use 2.5 mm² (13 AWG) or larger power feed cables and keep runs as short as possible.

For temporary installation, the mains cable may be fitted with a grounded connector.

The power cable color coding is given in the table.

- Connect the brown wire to live
- Connect the blue wire to neutral
- Connect the green/yellow wire to ground (earth)

Wire	Color	Symbol	Conductor
	Brown	L	live
	Blue	N	neutral
	green/yellow	 or 	ground (earth)

The device must be grounded/earthed and be able to be isolated from AC power. The AC power supply must incorporate a fuse or circuit breaker for fault protection.

To rig the fixture



Always use a secure means of secondary fixing such as a safety wire

Before installing;

- Verify that the attachment hardware is in good condition and designed to carry at least 10 times the fixture's weight.
- Verify that the structure can support at least 10 times the weight of all installed fixtures, clamps, cables, auxiliary equipment, etc.
- Verify that the clearance around the air vents is at least 0.1 meters (4 in.).
- Loosen the mounting bracket and adjust the fixture to the desired angle.
- Connect and arrange the power and data cables.
- Min. safety wire gauge = 3mm.

Controller Operation

This section describes how to operate the X-5/XC-5 with a DMX controller.

Data Connection

The X-5/XC-5 provided 5-pin XLR connectors for data connection. The pin-out on all connectors is pin 1 to shield, pin 2 to cold (-), and pin 3 to hot (+). There is no connection to pins 4 and 5.

To connect the data link

1. Connect the DMX data output from the controller to the fixture 5-pin input (male) socket.
2. Connect up to 31 additional fixtures output-to-input.
3. Insert a termination plug in the output of the last fixture on the link.

Data Connection Tips

- Use shielded twisted-pair cable designed for DMX devices: standard microphone cable cannot transmit control data reliably over long distance. 24 AWG cable is suitable for distances up to 300 meters (1000 ft.). Use heavier gauge cable and/or a DMX splitter/amp for longer distances.
- Do not overload the link. Up to 32 devices may be connected on a serial link.
- Terminate the link by installing a termination plug in the output socket of the last fixture. The termination plug, which is a male XLR plug with a 120 ohm, 0.25 watt resistor soldered between pins 2 and 3, absorb the control signal so it does not reflect and cause interference.

Setup

The fixture uses an interactive display for setting up DMX address and operation mode. Use the five buttons next to the display to navigate the setup structure (*Fig. 1*).

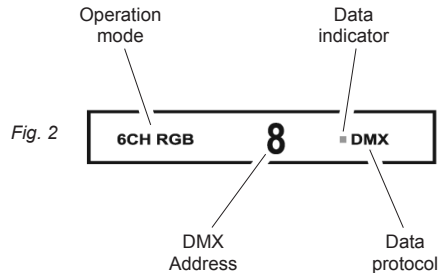
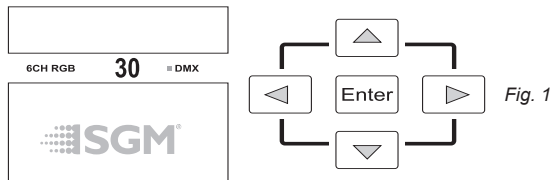

When the product is switched on, the fixture will be at its default setting showing the ROOT menu (*Fig. 2*).

The root menu show a summary of the setup information, including selected DMX address, operation mode, data indicator and protocol.

Setting DMX address

In the root menu the user can set the DMX start address directly by using the arrow UP and DOWN (*Fig. 3*).

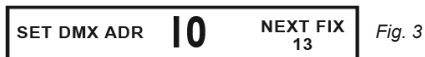

The fixture has a handy feature which displays the DMX start address for the next fixture (assuming you are connecting more than one fixture)

The selected start address is stored by pushing ENTER storing the DMX address.

Setting Mode

To enter the menu press ENTER, and then use the arrow up and down to select sub menus. Select the desired MODE and then press ENTER to store it.



Please refer to the chapter “DMX PROTOCOLS” to get further details of available DMX modes.

DMX Control Summary

For specific command values, see “DMX protocols” on page 15.

Intensity

Flash intensity can be set from minimum (blackout) to maximum in all DMX modes except 1 channel mode (where it is always at maximum intensity). A special pixel mode enables the fixture to be used as a blinder, where the intensity of blinder colour (XC-5 models) or each of three pixel segments (X-5 models) can be set.

Duration

Flash duration can be set from 0 to 650 ms on 50 Hz power supplies, or 0 to 530 ms on 60 Hz power supplies in 3, 4, 6 or 7 channel DMX modes. Flash duration is fixed in 1-channel DMX.

Rate

Flash rate can be set from 0 flashes per second to 25 flashes per second on 50 Hz power supplies or from 0 to 30 flashes per second on 60 Hz power supplies, when the fixture is set to 3, 4, 6 or 7 channel DMX mode. The flash rate is also controllable in 1-channel DMX mode.

Programmed Effects

Six programmed effects are available in 4 and 7 channel DMX modes. The effects may be altered using the intensity, duration, and rate controls:

- Ramp up: Light gradually increases in intensity, then blacks out.
- Ramp down: Light flashes to full intensity, then gradually fades.
- Ramp up-down: Light gradually increases and decreases.
- Random flash: Light flashes randomly with variable rate and intensity. Multiple units flash independently of each other.
- Lightning: The flashes simulate lightning. Duration is not adjustable.

Blinder Effect

The blinder effect, in which the light remains on for an extended period, is available in all DMX modes.

The combination of flash duration and rate prevents pauses between flashes. For example, the blinder effect can be achieved with a flash duration of 0.25 seconds (250 ms) and a flash rate of 4 flashes per second, or a flash duration of 0.05 seconds (50 ms) and a flash rate of 20 flashes per second.

In 3, 4, 6 & 7 channel DMX modes, the intensity of the blinder effect is controllable on channel 1. Lamp power is electronically regulated to prevent the lamp from overheating. The intensity falls as power is reduced.

Single Flash

To trigger single flashes, start with the intensity and flash rate at 0 and then set intensity on channel 1. When the value of channel 1 changes, the light will flash once with the programmed intensity, duration, and effect.

Service



Disconnect the product from the main power for at least 1 minute before servicing.

Fuse Replacement

The X-5/XC-5 uses a time-delay fuse for protection against current overload. The fuse is located inside the base on the main PCB of the fixture – next to the low voltage power supply. Fuses must be replaced by a certified professional.

Never bypass the fuse or replace it with one of another size or rating.

Firmware Updates

If you suspect that the firmware installed on your X-5/XC-5 becomes corrupted, please go to SGM website for further information on how to update firmware or contact your nearest dealer for assistance.

DMX Protocols

1 channel mode			
Channel	Value	Percent	Function
1	0-5	0-1	Blackout
	6-249	2-97	Flash rate, slow to fast
	250-255	98-100	Continuous blinder effect

3 channel mode			
Channel	Value	Percent	Function
1	0-5	0-1	Blackout
	6-255	2-100	Flash intensity - minimum to maximum
2	0-255	0-100	Flash duration: 0-650 ms @ 50 Hz AC 0-530 ms @ 60 Hz AC
3	0-5	0-1	No flash (trigger single flash using channel 1)
	6-255	2-100	Flash rate: 0.5-25 Hz @ 50 Hz AC 0.6-30 Hz @ 60 Hz AC

4 channel mode			
Channel	Value	Percent	Function
1	0-5	0-1	Blackout
	6-255	2-100	Flash intensity - minimum to maximum
2	0-255	0-100	Flash duration: 0-650 ms @ 50 Hz AC 0-530 ms @ 60 Hz AC
3	0-5	0-1	No flash (trigger single flash using channel 1)
	6-255	2-100	Flash rate: 0.5-25 Hz @ 50 Hz AC 0.6-30 Hz @ 60 Hz AC
4	0-5	0-1	No special effect
	6-42	2-16	Ramp up effect
	43-85	17-33	Ramp down effect
	86-128	34-50	Ramp up-down effect
	129-171	51-67	Random effect
	172-214	68-83	Lightning effect
	215-255	84-100	Spike effect

6 channel mode

Channel	Value	Percent	Function
1	0-5	0-1	Blackout
	6-255	2-100	Flash intensity - minimum to maximum
2	0-5	0-1	Blackout
	6-255	2-100	Red blinder intensity (<i>XC-5 models</i>), or Segment 1 intensity (<i>X-5 models</i>)
3	0-5	0-1	Blackout
	6-255	2-100	Green blinder intensity (<i>XC-5 models</i>), or Segment 2 intensity (<i>X-5 models</i>)
4	0-5	0-1	Blackout
	6-255	2-100	Blue blinder intensity (<i>XC-5 models</i>), or Segment 3 intensity (<i>X-5 models</i>)
5	0-255	0-100	Flash duration: 0-650 ms @ 50 Hz AC 0-530 ms @ 60 Hz AC
6	0-5	0-1	No flash (trigger single flash using channel 1)
	6-255	2-100	Flash rate: 0.5-25 Hz @ 50 Hz AC 0.6-30 Hz @ 60 Hz AC

7 channel mode

Channel	Value	Percent	Function
1	0-5	0-1	Blackout
	6-255	2-100	Flash intensity - minimum to maximum
2	0-255	0-100	Flash duration: 0-650 ms @ 50 Hz AC 0-530 ms @ 60 Hz AC
3	0-5	0-1	No flash (trigger single flash using channel 1)
	6-255	2-100	Flash rate: 0.5-25 Hz @ 50 Hz AC 0.6-30 Hz @ 60 Hz AC
4	0-5	0-1	No special effect
	6-42	2-16	Ramp up effect
	43-85	17-33	Ramp down effect
	86-128	34-50	Ramp up-down effect
	129-171	51-67	Random effect
	172-214	68-83	Lightning effect
	215-255	84-100	Spike effect

5	0-5	0-1	Blackout
	6-255	2-100	Green blinder intensity (<i>XC-5 models</i>), or Segment 2 intensity (<i>X-5 models</i>)
6	0-5	0-1	Blackout
	6-255	2-100	Green blinder intensity (<i>XC-5 models</i>), or Segment 2 intensity (<i>X-5 models</i>)
7	0-5	0-1	Blackout
	6-255	2-100	Blue blinder intensity (<i>XC-5 models</i>), or Segment 3 intensity (<i>X-5 models</i>)

7 channel Legacy mode

Channel	Value	Percent	Function
1	0-5	0-1	Blackout
	6-255	2-100	Flash intensity - minimum to maximum
2	0-5	0-1	Blackout
	6-255	2-100	Red blinder intensity (<i>XC-5 models</i>), or Segment 1 intensity (<i>X-5 models</i>)
3	0-5	0-1	Blackout
	6-255	2-100	Green blinder intensity (<i>XC-5 models</i>), or Segment 2 intensity (<i>X-5 models</i>)
4	0-5	0-1	Blackout
	6-255	2-100	Blue blinder intensity (<i>XC-5 models</i>), or Segment 3 intensity (<i>X-5 models</i>)
5	0-255	0-100	Flash duration: 0-650 ms @ 50 Hz AC 0-530 ms @ 60 Hz AC
6	0-5	0-1	No flash (trigger single flash using channel 1)
	6-255	2-100	Flash rate: 0.5-25 Hz @ 50 Hz AC 0.6-30 Hz @ 60 Hz AC

7	0-5	0-1	No special effect
	6-42	2-16	Ramp up effect
	43-85	17-33	Ramp down effect
	86-128	34-50	Ramp up-down effect
	129-171	51-67	Random effect
	172-214	68-83	Lightning effect
	215-255	84-100	Spike effect

Pixel mode			
Channel	Value	Percent	Blinder intensity
1	0-5	0-1	Blackout
	6-255	2-100	Red blinder intensity (<i>XC-5 models</i>), or Segment 1 intensity (<i>X-5 models</i>)
2	0-5	0-1	Blackout
	6-255	2-100	Green blinder intensity (<i>XC-5 models</i>), or Segment 2 intensity (<i>X-5 models</i>)
3	0-5	0-1	Blackout
	6-255	2-100	Blue blinder intensity (<i>XC-5 models</i>), or Segment 3 intensity (<i>X-5 models</i>)

Specifications *X-5 (Part #: 80090001) XC-5 (Part #: 80090002)*

PHYSICAL

Size (without bracket).....268 x 500 x 120 mm
Weight (without brackets / Cables).....5.8 kg

THERMAL

Maximum ambient temperature.....40° C (104° F)

CONTROL AND PROGRAMMING

USITDMX512-Acontrol.....1,3,4,6,7and7channel Legacy modes, pixelmode (3channels)

AC POWER

AC input.....Powercon
Approved AC power (EU).....208 - 240 V nominal, 50/60 Hz
Average current consumption.....4 A

FUSES

Primary fuse.....6.3 AT / 250 V

CONSTRUCTION

Housing.....Aluminium
Finish.....Electrostatic powder coating

INSTALLATION

Minimum clearance around fan and air vents.....0.1 m (4 in)

APPROVALS AND CERTIFICATIONS

Certified to.....CSA Std. C22.2 No. 166
Conforms to.....UL Std. 1573
Conforms to.....2004/108/EC: EMC Directive
Conforms to.....2006/95/EC: Low Voltage Directive
Conforms to.....2011/65/EU: RoHS2 Directive

Specifications subject to change without notice



Users notes



SGM A/S · Sommervej 23 · 8210 Aarhus V · Denmark
Tel +45 70 20 74 00 · info@sgmlight.com · www.sgmlight.com